

HD 35-A

2-WEGE-AKTIVBOX

BESCHREIBUNG

Transparenter Klang, hohe Ausgangsleistung, Zuverlässigkeit, Robustheit und einfacher Transport – das sind die Zutaten. Wir haben sämtliche Komponenten der D-Line Serie durch eine komplette Überarbeitung der Gehäuse verbessert: robuste Hochleistungslautsprecher mit unverkennbarer Verwandtschaft zu anderen bewährten Produkten wie der ART Serie 7 und den Top-Modellen der TT+ Reihe. Höchste Klangqualität gepaart mit modernster Feature-Ausstattung, die Verlässlichkeit und Widerstandsfähigkeit für den intensiven Tourn-Einsatz gewährleistet. Erste Wahl als primärer FOH-Lautsprecher für portable PA-Anlagen, Hochleistungs-Bühnenmonitor oder Multifunktionslautsprecher für Verleihfirmen.



FUNKTIONEN

- 132 dB maximaler Schalldruckpegel
- 1400 Watt Peak-Leistung
- Digitale Signalverarbeitung mit FIRPHASE
- Trennfrequenz bei 800 Hz für perfekte Sprach- und Gesangswiedergabe
- 1,4-Zoll-Titanmembran-Kompressionstreiber, 3-Zoll-Schwingspule Neodym-Magnet
- 15-Zoll-Hochleistungstieftöner
- Constant-Directivity-Horn mit großer Abdeckung von 90° x 60°
- Geräuscharme Lüfterlose Class-D-Endstufe

SPEZIFIKATIONEN

Spezifikation	Frequenzgang:	45 Hz ÷ 20000 Hz
	Max SPL @ 1m:	132 dB
	Horizontaler Abstrahlwinkel:	90°
	Vertikaler Abstrahlwinkel:	60°
Schallwandler	Kompressionstreiber:	1.4", 3.0" v.c
	Woofers:	15", 3.0" v.c
Input/Output sektion	Eingangssignal:	bal/unbal
	Eingangsbuchsen:	XLR, Jack
	Ausgangsanschlüsse:	XLR
	Eingangsempfindlichkeit:	-2 dBu/+4 dBu
	Mic Eingangsempfindlichkeit:	-32 dBu
Prozessor	Übergangsfrequenz:	800 Hz
	Schutzschaltungen:	Thermal, RMS
	Limiter:	Soft Limiter
	Steuerung:	Volume, Boost, Mic/Line
Power sektion	Gesamtleistung:	1400 W Peak, 700 W RMS
	HF Bereich:	400 W Peak, 200 W RMS
	Tiefe Frequenzen:	1000 W Peak, 500 W RMS
	Kühlung:	Convection
	Verbindungen:	Powercon IN/OUT
Physikalische daten	Gehäuse Material:	PP Composite
	Hardware:	1 x M10 top, 1 x M10 bottom, 2 x M10 side
	Griffe:	1 Top, 2 Side
	Pole Mount/Cap:	Yes
	Gitter:	Steel
	Farbe:	Black
Größe	Höhe:	714 mm / 28.11 inches
	Breite:	442 mm / 17.4 inches
	Tiefe:	397 mm / 15.63 inches
	Gewicht:	22 kg / 48.5 lbs
Versandinformationen	Verpackung Höhe:	750 mm / 29.53 inches
	Verpackung Breite:	440 mm / 17.32 inches
	Verpackung Tiefe:	480 mm / 18.9 inches
	Verpackungsgewicht:	24.5 kg / 54.01 lbs



ARTIKEL-NUMMER

• **13000592**

HD 35-A

115V

EAN 8024530016920

• **13000591**

HD 35-A

220-240V

EAN 8024530016661

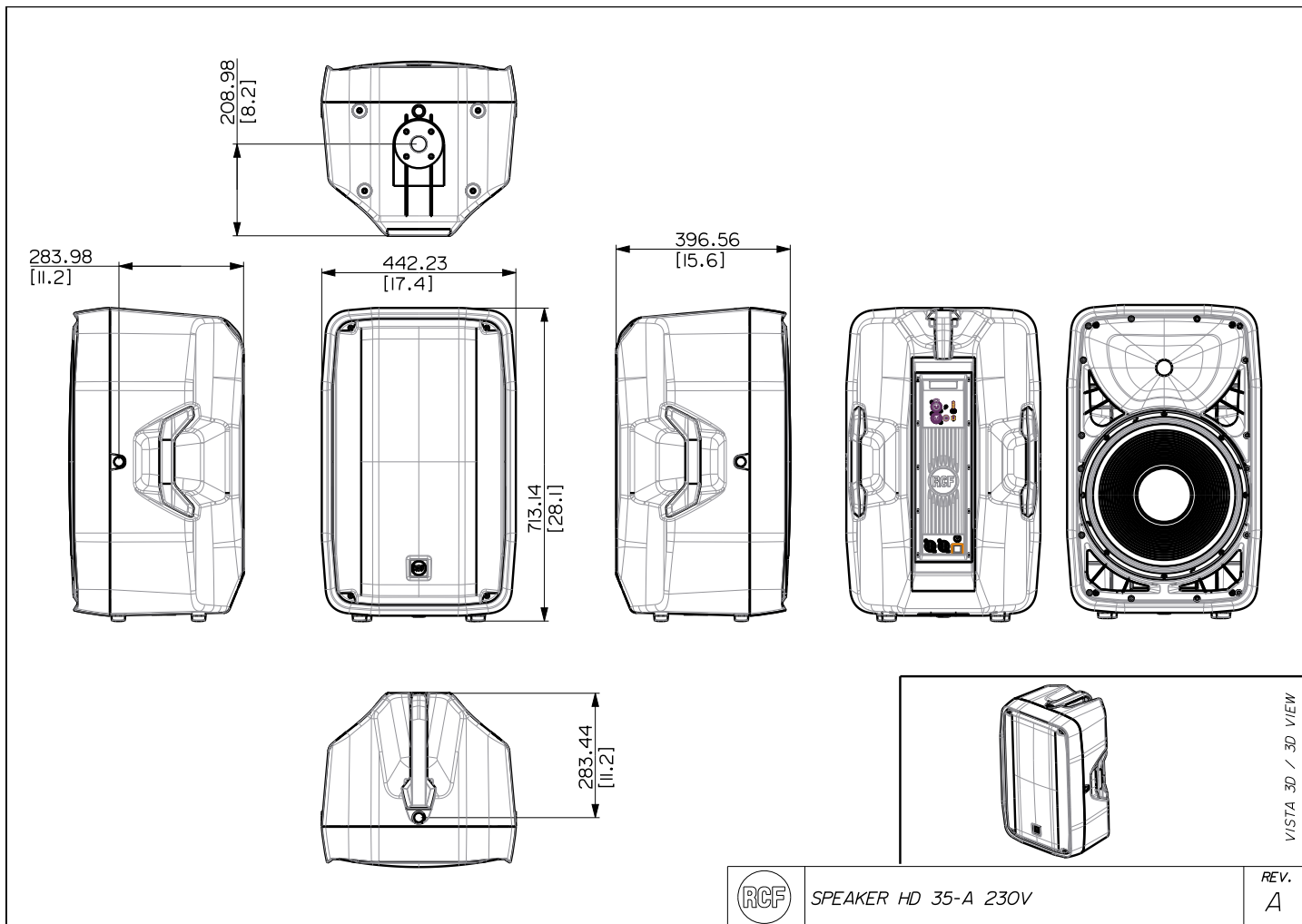

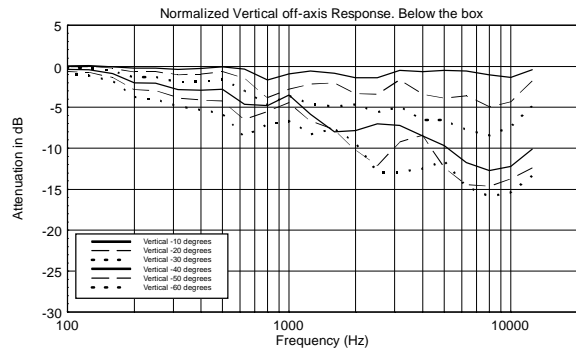
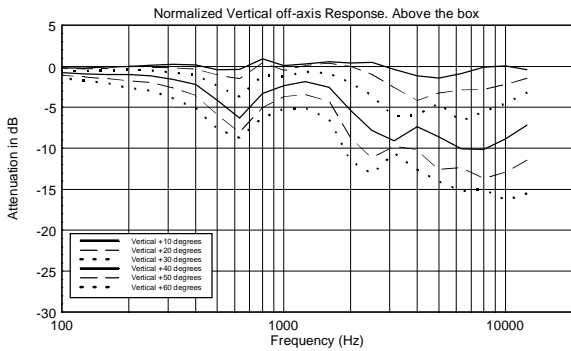
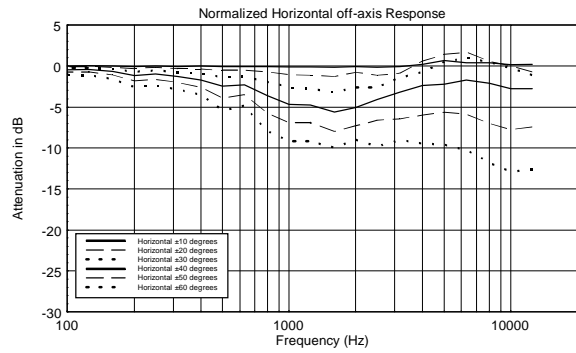
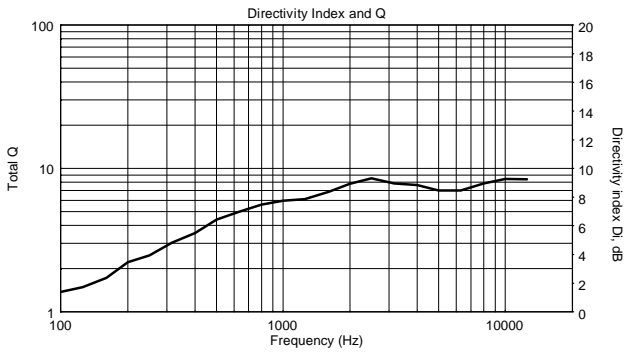
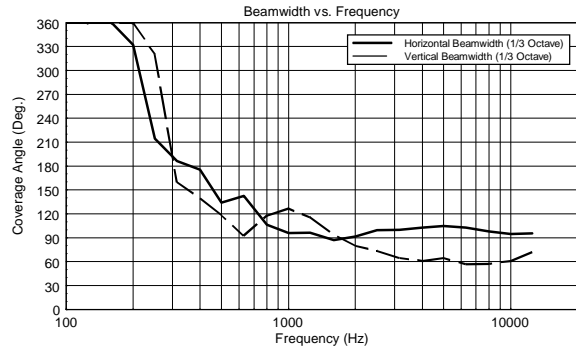
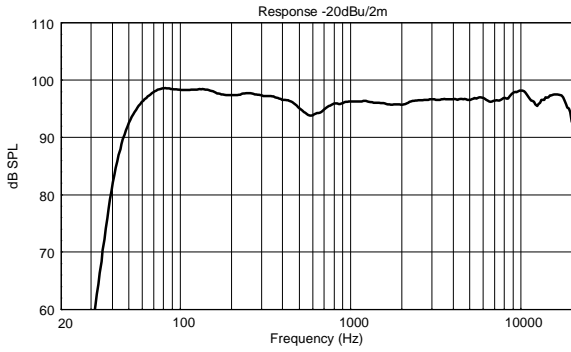

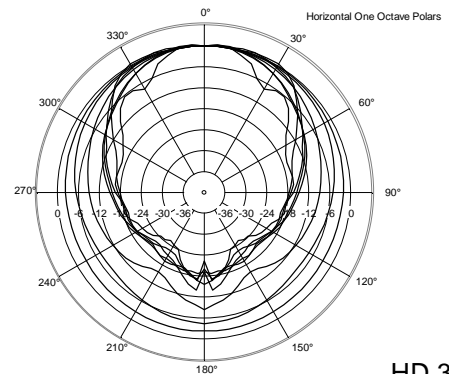
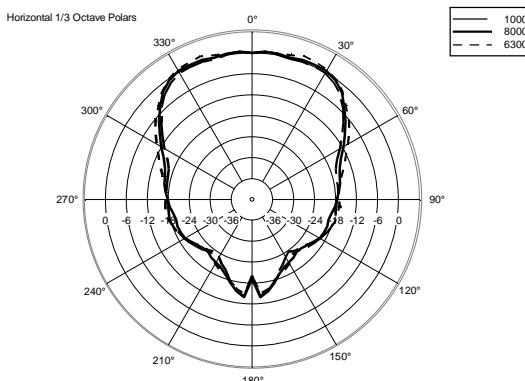
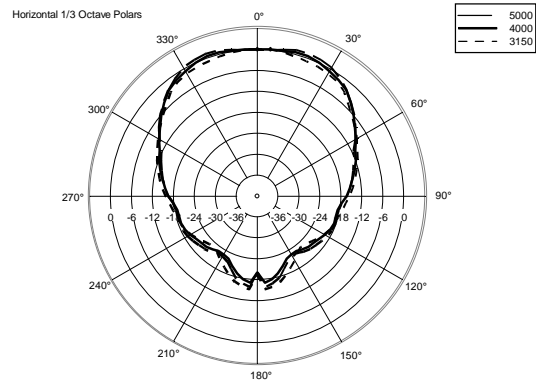
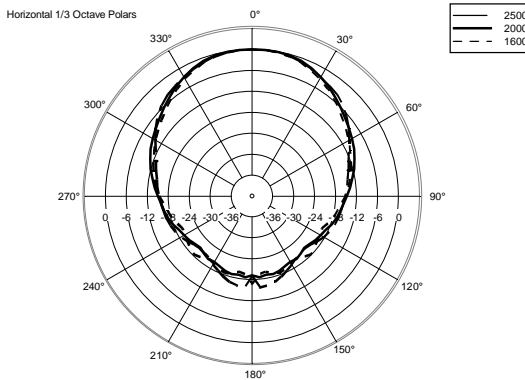
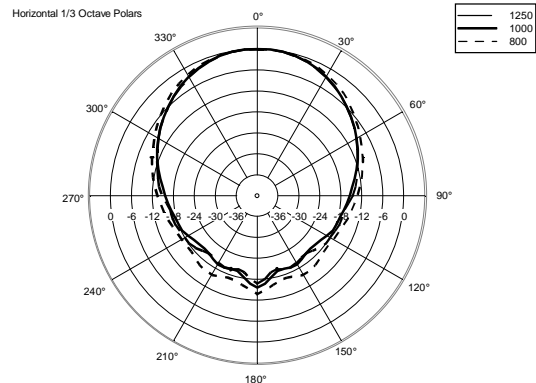
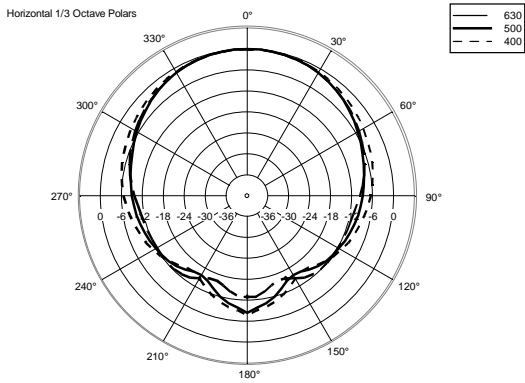
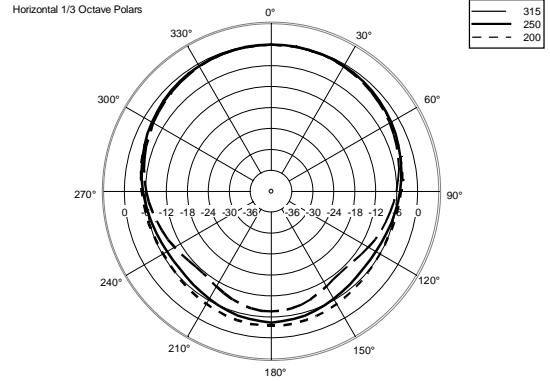
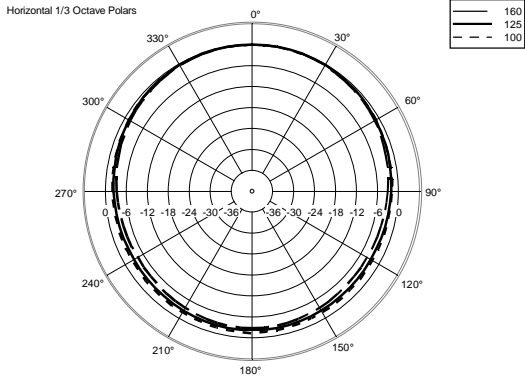

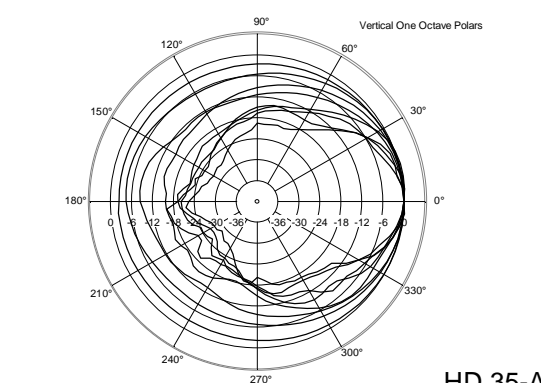
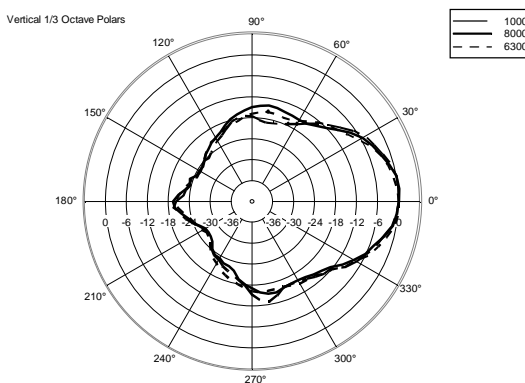
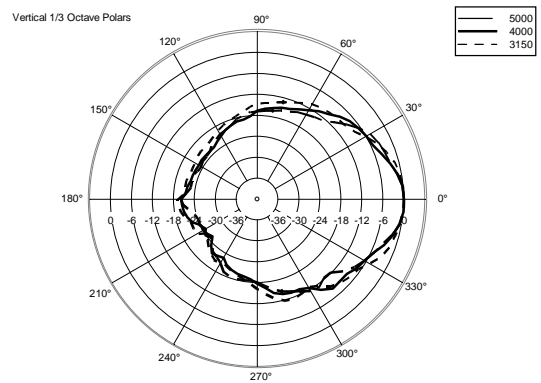
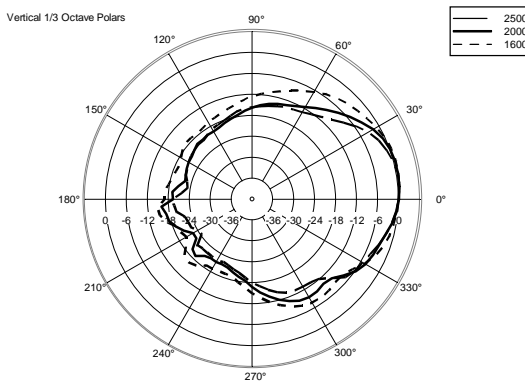
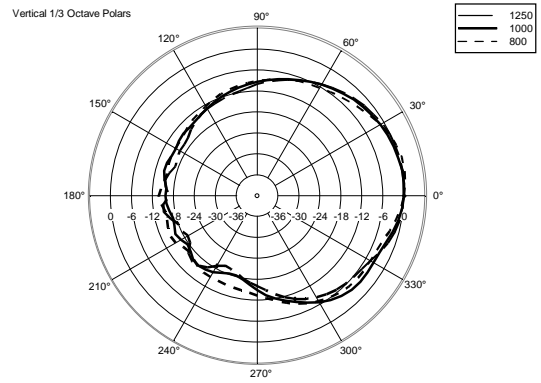
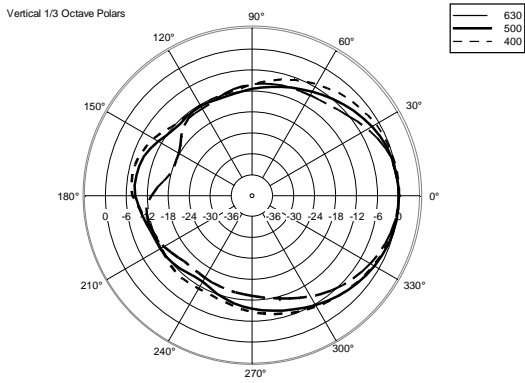
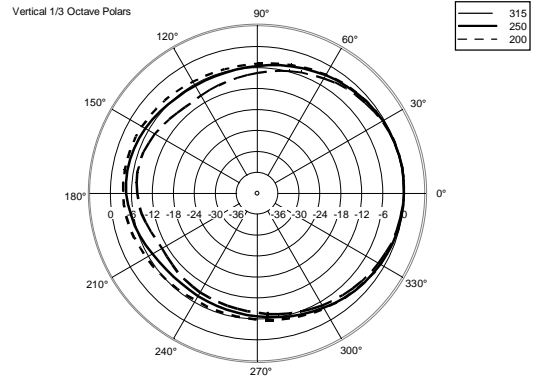
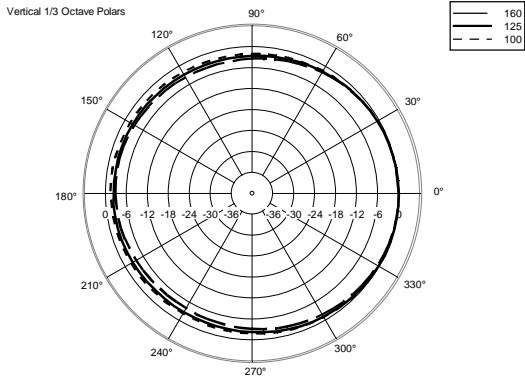







ZUBEHÖR

	AC PM-M20	ARTIKEL- NUMMER EAN:	13360067 8024530014599
	AC PMX POLE MOUNT M20	ARTIKEL- NUMMER EAN:	13360232 8024530010058
	AC PRO-FS PROFESS. LOCKING FLOOR STAND	ARTIKEL- NUMMER EAN:	13360109 8024530006471
	AC PRO-PM PROFESS. LOCKING POLE MOUNT	ARTIKEL- NUMMER EAN:	13360110 8024530006488
	COVER CVR HD 15	ARTIKEL- NUMMER EAN:	13360438 8024530016708
	KIT EYEBOLT 4 X	ARTIKEL- NUMMER EAN:	13360031 8024530018870